

LARYVOX® INSERTER UNIEK PRO

REF 25930

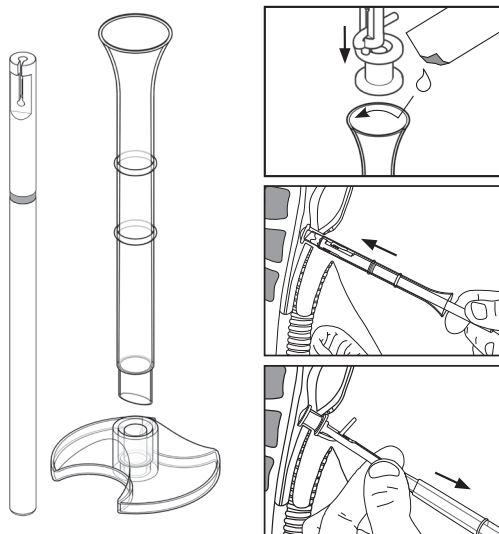

- ▶ De **LARYVOX® INSERTER UNIEK PRO** bestaat uit een plaatsingsinstrument en een applicator. Hij dient voor een optimale anterograde plaatsing of het vervangen van een **LARYVOX® UNIEK** stemprothese.
- ▶ Het plaatsingsinstrument beschikt over een fixeermogelijkheid om de stemprothese veilig te plaatsen.
- ▶ De applicator maakt het mogelijk om de stemprothese moeiteloos te plaatsen en is in enkele stappen gebruiksklaar.
- ▶ De afgeronde applicatorpunt bevordert bovendien een zachte plaatsing en maakt het vervangen van de stemprothese zo comfortabel mogelijk.

BESTELINFORMATIE

LARYVOX® INSERTER	REF 25930
1 x plaatsingsinstrument (wit)	
1 x applicator	
1 x adapter	
1 x glijgel	
1 x gebruiksaanwijzing	

Deze inserter wordt uitsluitend gebruikt in combinatie met de **LARYVOX® UNIEK**.

De stemprothese is niet in de leveromvang inbegrepen en moet apart besteld worden. Neem de gebruiksaanwijzing van de stemprothese in acht!

Product**LARYVOX® INSERTER UNIEK PRO****VE**

1 stuk























REF**25930**

























LARYVOX® INSERTER

OPDRACHT

25900	25910	25915	25920	25925 25930
LARYVOX® INSERTER	LARYVOX® INSERTER EXPERT	LARYVOX® INSERTER EXPERT SMALL	LARYVOX® INSERTER SPECIAL	LARYVOX® INSERTER UNIEK
Kleur				
				
				

Let van tevoren op de lengte (xx) van de te plaatsen stemprothese.

REF	Benaming stemprothese	Lengte	INSERTER
20 FRENCH			
AD20xx-NS	ADVANTAGE Indwelling 20 Fr. Voice Prosthesis	06-14 mm	
AD2004-NS	ADVANTAGE Indwelling 20 Fr. Voice Prosthesis	04 mm	
AS20xx-NS	ADVANTAGE Indwelling 20 Fr. Voice Prosthesis	06-14 mm	
AS2004-NS	ADVANTAGE Indwelling 20 Fr. Voice Prosthesis	04 mm	
DV20xx-LF	DUAL VALVE Indwelling LF 20 Fr. Voice Prosthesis	06-14 mm	
DV20xx-NS	DUAL VALVE Indwelling 20 Fr. Voice Prosthesis	06-14 mm	
IN2004-NS	CLASSIC Indwelling 4 mm 20 Fr. Voice Prosthesis	04 mm	
IN20xx-NS	CLASSIC Indwelling 20 Fr. Voice Prosthesis	06-20 mm	
IN2004-LEF	CLASSIC Indwelling LEF 4 mm 20 Fr. Voice Prosthesis	04 mm	
IN20xx-LEF	CLASSIC Indwelling LEF 20 Fr. Voice Prosthesis	06-14 mm	
IN20xx-IR	CLASSIC Indwelling IR 20 Fr. Voice Prosthesis	06-12 mm	
IN2004-LEIR	CLASSIC Indwelling LEIR 20 Fr. 4 mm Voice Prosthesis	04 mm	
IN20xx-LEIR	CLASSIC Indwelling LEIR 20 Fr. Voice Prosthesis	06-08 mm	
IN20xx-LESL	CLASSIC Indwelling LESL 20 Fr. Voice Prosthesis	05 und 07 mm	
IN2004-LETO	TEP Occluder Indw. LETO 20 Fr. 4 mm Voice Prosthesis	04 mm	
IN20xx-LETO	TEP Occluder Indw. LETO 20 Fr. Voice Prosthesis	06-14 mm	
IN2004-LF	CLASSIC Indwelling LF 20 Fr. 4 mm Voice Prosthesis	04 mm	
IN20xx-LF	CLASSIC Indwelling LF 20 Fr. Voice Prosthesis	06-14 mm	
IN20xx-SL	CLASSIC Indwelling SL 20 Fr. Voice Prosthesis	05,07 und 09 mm	
IN20xx-SO	CLASSIC Indwelling STERIL 20 Fr. Voice Prosthesis	08-14 mm	
25010-xx	LARYVOX® Uniek U.L.R. 21 Fr.	05-13 mm	
25020-xx	LARYVOX® Uniek U.L.R. 24 Fr.	05-13 mm	

REF	Benaming stemprothese	Lengte	INSERTER
16 FRENCH			
AS1604-NS	ADVANTAGE Indwelling 16 Fr. Voice Prosthesis	04 mm	
AS16xx-NS	ADVANTAGE Indwelling 16 Fr. Voice Prosthesis	06-14 mm	
IN1604-NS	CLASSIC Indwelling 4 mm 16 Fr. Voice Prosthesis	04 mm	
IN16xx-NS	CLASSIC Indwelling 6 mm 16 Fr. Voice Prosthesis	06-20 mm	
IN16xx-SO	CLASSIC Indwelling STERIL 10 mm 16 Fr. Voice Prosthesis	08-14 mm	
IN16xx-IR	CLASSIC Indwelling IR 16 Fr. Voice Prosthesis	06-12 mm	
IN1604-LEF	CLASSIC Indwelling LEF 4 mm 16 Fr. Voice Prosthesis	04 mm	
IN16xx-LEF	CLASSIC Indwelling LEF 16 Fr. Voice Prosthesis	06-14 mm	
IN16xx-LESL	CLASSIC Indwelling LESL 16 Fr. Voice Prosthesis	05 und 07 mm	
IN1604-LETO	CLASSIC Indwelling LETO 4 mm 16 Fr. Voice Prosthesis	04 mm	
IN16xx-LETO	CLASSIC Indwelling LETO 16 Fr. Voice Prosthesis	06-14 mm	
IN1604-LF	CLASSIC Indwelling LF 4 mm 16 Fr. Voice Prosthesis	04 mm	
IN16xx-LF	CLASSIC Indwelling LF 16 Fr. Voice Prosthesis	06-14 mm	
IN16xx-SL	CLASSIC Indwelling SL 16 Fr. Voice Prosthesis	05,07 und 09 mm	
IN16xx-SO	CLASSIC Indwelling STERIL 16 Fr. Voice Prosthesis	08-14 mm	
Gebruik met gelcapsuletechniek			
IN20xx-NS	CLASSIC Indwelling 20 Fr. Voice Prosthesis	06-20 mm	
AD20xx-NS	ADVANTAGE Indwelling 20 Fr. Voice Prosthesis	06-14 mm	
AS20xx-NS	ADVANTAGE Indwelling 20 Fr. Voice Prosthesis	06-14 mm	
IN20xx-LF	CLASSIC Indwelling LF 20 Fr. Voice Prosthesis	06-14 mm	
IN20xx-LEF	CLASSIC Indwelling LEF 20 Fr. Voice Prosthesis	06-14 mm	
IN20xx-SL	CLASSIC Indwelling SL 20 Fr. Voice Prosthesis	05,07 und 09 mm	
IN20xx-LEIR	CLASSIC Indwelling LEIR 20 Fr. Voice Prosthesis	05 und 07 mm	
IN20xx-LESL	CLASSIC Indwelling LESL 20 Fr. Voice Prosthesis	05 und 07 mm	
IN20xx-IR	CLASSIC Indwelling IR 20 Fr. Voice Prosthesis	06-12 mm	
IN20xx-LETO	TEP Occluder Indw. LETO 20 Fr. Voice Prosthesis	06-14 mm	



Andreas Fahl Medizintechnik-Vertrieb GmbH is de exclusieve distributeur voor Blom-Singer® producten in geselecteerde Europese landen. Blom-Singer® is een geregistreerd handelsmerk van Freudenberg Medical, LLC.